

**Model 860M1
Model 860M5
Model 860M6**



IR-EYE™

**Directional Long Range
Narrow Field-of-View
Passive Infrared Thermal Telescopes**

with:

**Analog Output(s) to mate with
Contractor-Developed Signal Processing
or Legacy Systems**

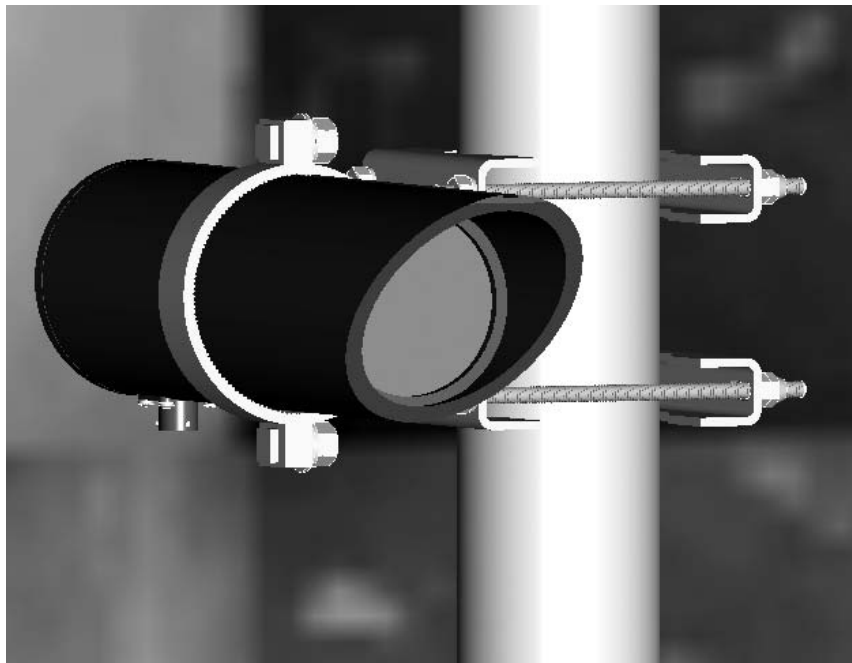

Please note: These telescopes do not provide either relay or TTL outputs. They are made available for special signal processing systems. For units that do provide relay and TTL outputs, see Eltec Models 864 and 864M3.

THIS PAGE LEFT INTENTIONALLY BLANK

SECTION 1

INTRODUCTION

- 1.1 RANGE AND PERFORMANCE
- 1.2 BASICS OF PASSIVE INFRARED (PIR) DETECTION
- 1.3 DESCRIPTION
- 1.4 FUNCTION
- 1.5 FIELD-OF-VIEW
- 1.6 DETECTABILITY CONSIDERATIONS
- 1.7 ENVIRONMENTAL CONSIDERATIONS
- 1.8 INSTALLATION CONSIDERATIONS
- 1.9 POTENTIAL FALSE ALARM SOURCES

SECTION 2

INSTALLATION AND OPERATION

- 2.1 INTRODUCTION AND PRECAUTIONS
- 2.2 UNPACKING
- 2.3 POWER REQUIREMENTS
- 2.4 CONNECTION TO EXTERNAL EQUIPMENT
- 2.5 TAMPER SENSE (MODEL 860M5 AND 860M6 ONLY)
- 2.6 MECHANICAL OUTLINE
- 2.7 MOUNTING
- 2.8 MOUNTING AND ACCESSORIES
- 2.9 OPERATION
- 2.10 ALIGNMENT
- 2.11 WALK TESTING
- 2.12 WALK TESTING FIELD-OF-VIEW
- 2.13 MAINTENANCE
- 2.14 SPECIFICATIONS
- 2.15 ACCESSORIES

SECTION 1 - - INTRODUCTION

1.1 RANGE AND PERFORMANCE

The range of these telescopes is nominally 500 feet (with appropriate customer supplied electronics) for personnel and farther for vehicles. HOWEVER, range is dependent on the thermal contrast between the target and the background. You will find that this varies throughout the day, with weather conditions, and even with the clothing of the target. If your application involves detecting someone crossing through a field of grass, you will find that the undulation of the grass on a windy day will appear on the analog output signals. Thus the system is limited by the thermal contrast of the target against the background as well as thermal background noise.

For shorter range (~200 ft) or more covert applications, Eltec suggests the Model 8502M3 or 8502M7. The Model 8502M3 is a short range version of the Model 860M5 and the Model 8502M7 is a short range version of the Model 860M6. The short range and long range versions are pin for pin compatible and use the same connector. The short and long range versions differ with regard to directionality (refer to the Directionality Considerations section for the appropriate Model).

Performance will greatly depend on the amplification you use with the telescope's analog output including your bandpass filtering. Many feel that human motion is sufficiently detected through the frequency range of 0.3 to 3 Hz. Yet, the conditions of your application may require a broadening of that range - - with a consequent increase in noise. Eltec recommends that you AC-couple the telescope's analog output. The current draw per channel should be typically 8 microamps.

1.2 BASICS OF PASSIVE INFRARED (PIR) DETECTION

Each person, object or animal emits infrared energy as a function of its surface temperature and size. For temperatures around ambient the maximum of the radiated energy is in the region of 10 microns (20 times the wavelength of visible light). Thermal changes, relative to the background, within the telescope's field of view as produced by a moving target generate a signal which will trigger an alarm.

PIR detection has become the most widely used approach for indoor intrusion detection and Eltec provides a proven high reliability sensor for outdoor applications.

PIR detection does not require an emitter, but makes use of radiation which is already there - 100% natural and harmless. The fact that no radiation is emitted also means that:

- A sensor unit cannot be detected by any technical means. Like the human eye, it is completely passive in operation.
- No license is required as for microwaves.
- No eye protection required as with many active IR devices.
- Neighboring units will not interfere with each other.
- Directional information can be obtained utilizing an internal two channel detector and appropriate external electronic circuit.

1.3 DESCRIPTION

These telescopes are specifically designed for use as a component in a total security system for long range detection of people and vehicles. Eltec's passive infrared thermal telescopes have been

deployed worldwide for over two decades in security systems for industrial, governmental and military installations. The rugged, watertight, hermetically sealed construction of these telescopes make them ideal for outdoor applications. The telescope's use of state-of-the-art detector technology and precision optics, coupled with advanced signal processing optimizes the discrimination of moving targets from other events. This technology is an exciting alternative to microwave or active infrared links and is also ideal in critical applications where dual technologies are desired. The simple installation process, and the variety of options available, make these telescopes well suited for a number of applications, some of which include detection of personnel, vehicles, boats, airplanes, fires, explosions, etc. The telescopes can be used in both fixed and temporary installations to monitor events at long distances.

1.4 FUNCTION

A person or vehicle will always have a temperature contrast in respect to the background, producing a change of radiation within the field of view when passing through it. This temperature contrast can be as little as 1°C or less (either positive or negative) for a person at the nominal distance of 500ft to trigger the alarm. A precision mirror focuses the radiation onto a twin channel pyroelectric detector which will produce a defined signal from a moving target. Two stage optical filtering restricts the radiation to the "atmospheric window" (8 - 14 microns) where the effects of the normal constituents of the atmosphere (particularly humidity) least affect the transmission of infrared radiation. This double optical filtering minimizes unwanted radiation from sunlight or headlights which otherwise may produce false alarms.

1.5 FIELD-OF-VIEW

Please note: This manual discusses installation and operation of the Model 860M1, 860M5 and 860M6 telescopes. The field of view is the same for all models. The difference between the models is that the 860M5 and 860M6 have the added tamper sense feature.

The field of view consists of two distinct segments. The area covered as a function of distance is shown in Figs 1.1, 1.2 and 1.3. This standard field of view is ideally suited for observation of a defined spot from a distance.

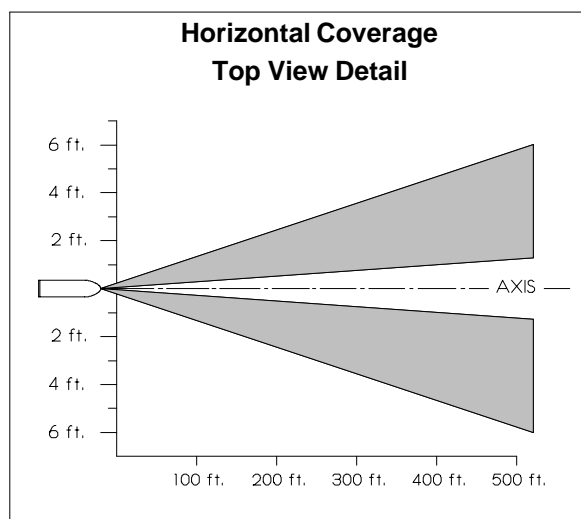

Figure 1.1

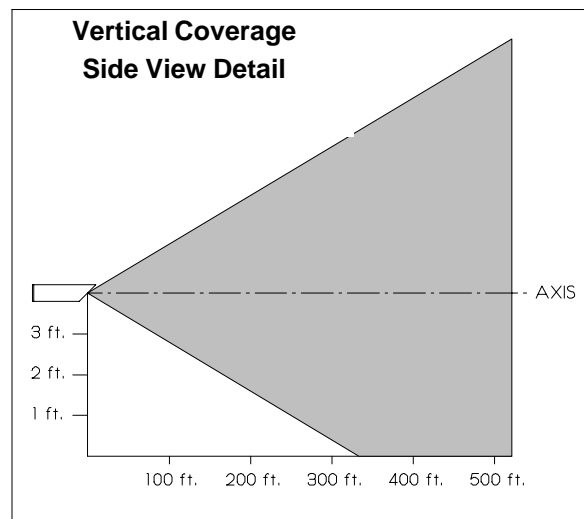

Figure 1.2

Data is calculated and subject to variations in environmental changes

Please note that a non-directional unit with curtain coverage similar to the Model 864 is available. This is the Model 860M4 without internal electronics. For further details, please contact the Technical Support staff at Eltec Instruments.

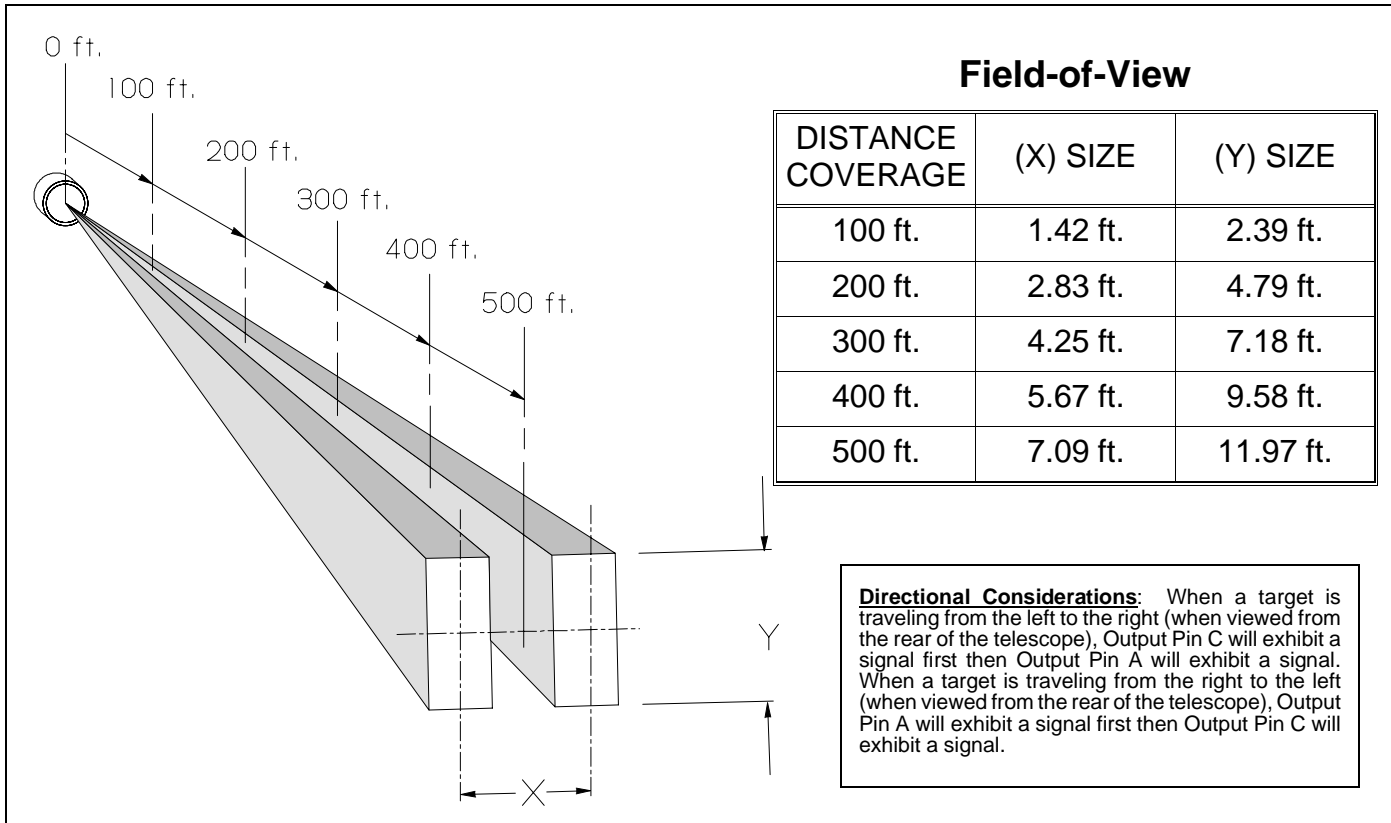

Figure 1.3

Data is calculated and subject to variations in environmental changes

1.6 DETECTABILITY CONSIDERATIONS

These passive infrared telescopes produce an analog signal when seeing a change of optical radiation corresponding to a movement within or across the field of view. Although the telescopes are most sensitive to movements across the field of view, movement towards the telescope will also be detected with a high degree of probability.

1.7 ENVIRONMENTAL CONSIDERATIONS

One of the major concerns is the influence of various weather conditions on the detection range. Calculations verified by actual tests show that the infrared signal attenuation can almost be neglected for points 1 to 9 on the International Visibility Scale (see Table 1) corresponding to dense fog and perfectly pure air, respectively. Only for visibility 0 (very dense fog) will the attenuation be significant, but detection range will still be typically up to 50% more than the distance the human eye will see.

1.8 INSTALLATION CONSIDERATIONS

These telescopes are most frequently used when the intruder's direction is important or critical. They may be used across a natural "trap" zone like a gully, river ford, or trail and for perimeter protection. They are often used across a road to signal that a vehicle has passed and in what direction. They are frequently aimed across runways of isolated or covert airstrips.

For perimeter protection, Eltec's "curtain coverage" telescopes are generally preferred. However, if intruders are most likely to be walking or running and/or small animals have been a source of false alarms, the narrow FOV telescopes aimed horizontally to the side of a building, a mound or other vertical object may be an excellent solution.

In perimeter protection applications, or similar fixed installations for people detection, it is recommended to limit the required detection range to 300 ft by grounding out the telescope. Longer sections of a perimeter can be divided into portions of 300 ft, each being covered by one telescope (see Fig 1.4). This kind of set-up will give reliable detection under virtually all climatic conditions.

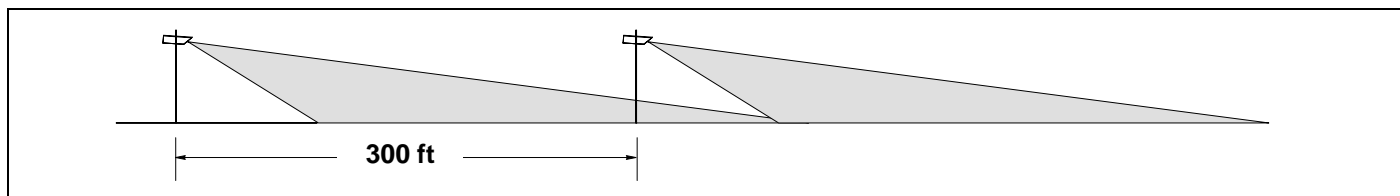

Figure 1.4

It is important to note that the range of the telescope is not limited by, but a function of, size and temperature of the target. A car or an airplane may trigger an alarm when crossing the field of view at a mile distance depending on the conditions. This is avoided in practice by pointing the telescopes slightly downward or by having the telescopes face a defined background (wall, hill, or embankment).

An alternate, which is commonly chosen in high security applications, is to protect a given section by two telescopes facing each other (see Fig 1.5). By electrically linking two units in an "and" function, an alarm will only be triggered if both telescopes give a simultaneous alarm, indicating movement seen by both units. Naturally this type of set-up greatly reduces the false alarm probability. Additionally, such an arrangement, if switched to an "or" function at certain times of increased risk of intrusion or very poor visibility, can be made extremely sensitive.

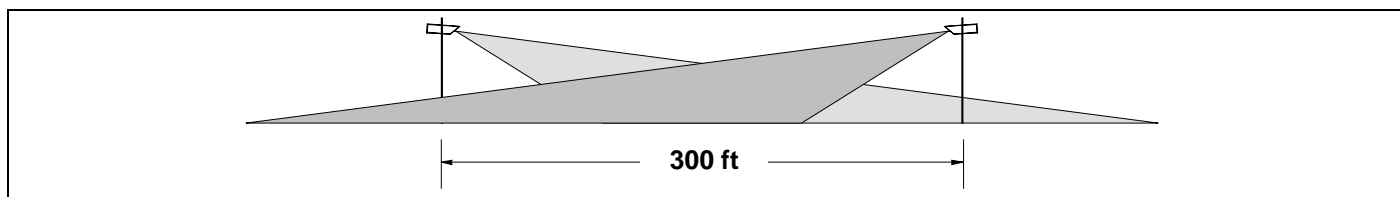

Figure 1.5

For protection of a corner, the following installations are recommended (Figs 1.6 & 1.7)

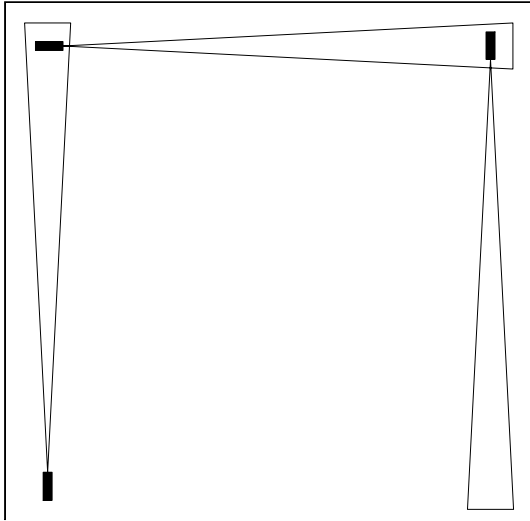

Figure 1.6

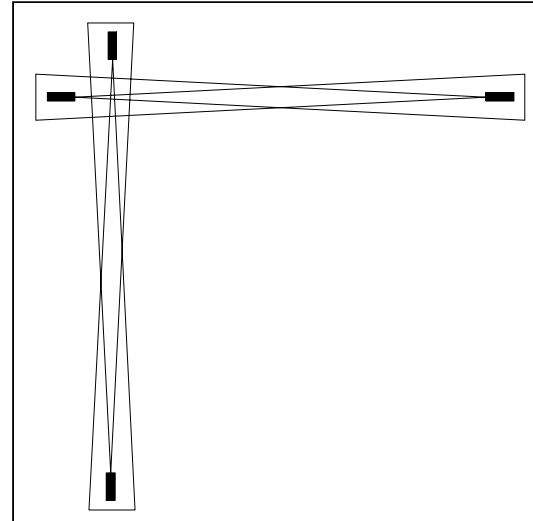

Figure 1.7

For Perimeter with Chain-Link Fence:

If the telescope is aimed at the fence, it will "see through" the fence and alarm in response to people and vehicles on the other side. To avoid this, the telescopes can be aimed at the ground. Or a panel can be added to the fence. Possible materials: marine plywood or acrylic plastic sheet (this is opaque in the long wave infrared). See Fig 1.8.

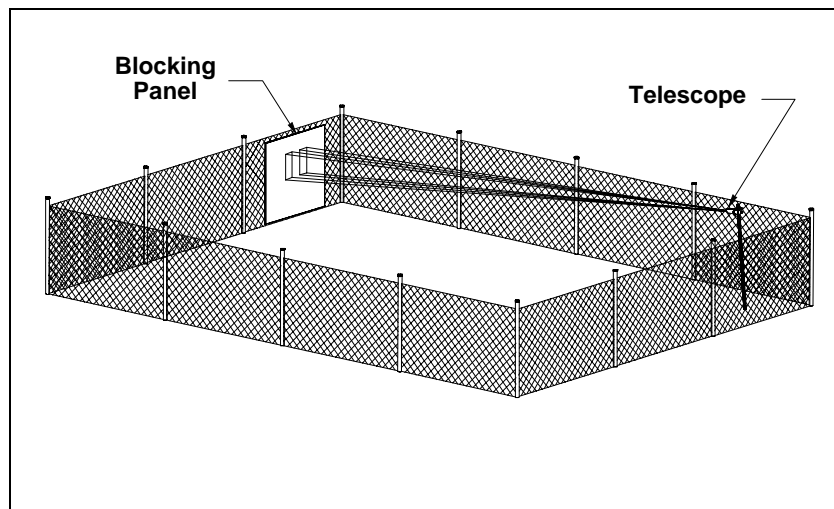

Figure 1.8 - Use of a Blocking Panel

1.9 POTENTIAL FALSE ALARM SOURCES

Various sources may affect the performance of an outdoor security system. For instance, DO NOT aim the telescope into the horizon (straight out), UNLESS you are aiming into a wall, the side of a building or an embankment that is within your monitored perimeter. Although the telescope will detect a person at 500 feet under most conditions, it may detect a larger heat source, like a truck or an airplane, to a distance greater than several thousand feet, or thermal perturbations in distant

atmospheric masses. Thus, the end of the field of view should be a stable thermal background (something that changes temperature very slowly, like the earth or a concrete wall, etc.). See Fig 1.9. If the telescope seems to be giving false trips, the first thing to check (after verifying that there is proper voltages to electronics and telescope) is the aiming, to make sure that detection of motion of distant objects is not the source of unwanted alarm signals. REFER TO OPERATION, AND ALIGNMENT SECTIONS. Passive infrared detection can perform exceptionally well under almost all conditions.

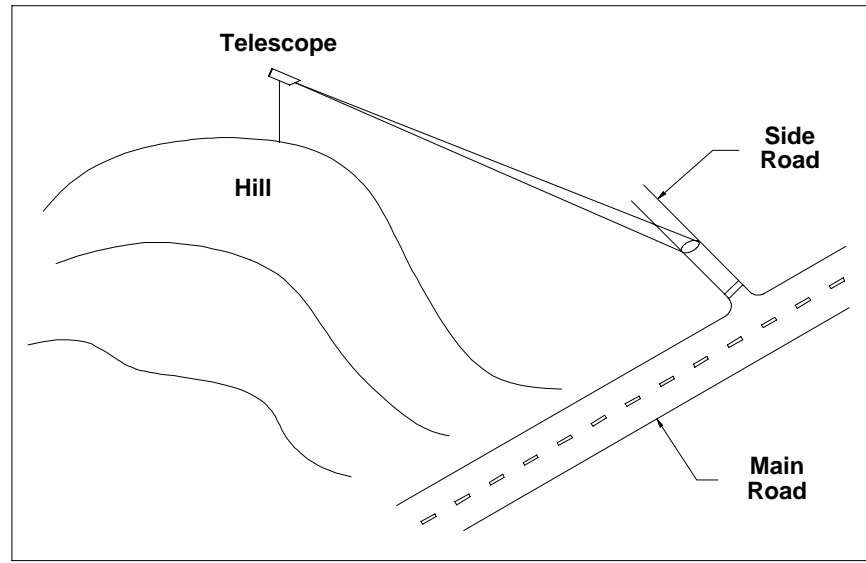

Figure 1.9 - Grounding with Actual Terrain

SECTION 2 - - - INSTALLATION AND OPERATION

2.1 INTRODUCTION AND PRECAUTIONS

Before installing the telescope, please read this section carefully. Should any difficulties arise, contact your supplier or Technical Support staff at Eltec Instruments directly.

IMPORTANT NOTICES FOR INSTALLATION AND SERVICE PERSONNEL:

Handle the telescope with care

The unit is a precision instrument and will not function to its specifications if subjected to mechanical shock or undue stress.

DO NOT point the unit into the sun or other intense source of infrared radiation

The telescope contains precision optical components that focus infrared energy onto very sensitive pyroelectric components. Intense sources of infrared will destroy these components and possibly damage the optics.

DO NOT touch the front window with bare hands

Salts and acids from the hands may damage the surface of the window. To clean the window, use only a soft, clean cloth. Cloth may be moistened with distilled water or alcohol in severe conditions. Clean the window very gently, do not apply undue pressure as the window is fragile and may be damaged or broken.

Use precautions in lightning storms

In lightning prone areas, take measures to arrest lightning discharges and electrostatic buildup.

2.2 UNPACKING

Remove the unit from the shipping container and carefully check for signs of damage. Any such damage should be reported to your supplier or to the Technical Support staff at Eltec Instruments directly. Do not attempt to install a damaged unit until advice has been obtained.

2.3 POWER REQUIREMENTS

The telescope can be used over a wide voltage range from 3.0V to 15V DC. The voltage must be DC, any ripple on the supply voltage will be present at the output of the telescope. Avoid running low voltage DC next to AC power cables over long distances. Induced AC ripple and noise in the DC supply will be present at telescope's output.

2.4 CONNECTION TO EXTERNAL EQUIPMENT

Model 860M1

PIN	DESIGNATION
A	OUTPUT
B	GROUND
C	OUTPUT
D	V+ (3 TO 15V DC)
E	N/C
F	N/C

Model 860M5 and 860M6

PIN	DESIGNATION
A	OUTPUT
B	GROUND
C	OUTPUT
D	V+ (3 TO 15V DC)
E	N/C
F	TAMPER SENSE

2.5 TAMPER SENSE (MODEL 860M5 AND 860M6 ONLY)

The difference between the Model 860M5 and the Model 860M6 are the internal tamper sense connections. The Model 860M5 tamper sense connects to V+ through a 2 megohm resistor. The Model 860M6 tamper sense is connected to ground.

2.6 MECHANICAL OUTLINE

Optics and detector are sealed into a rugged watertight hermetically sealed PVC housing providing exceptional thermal isolation and immunity to thermal shock. RFI protection is provided for use near strong RF sources such as radar and communications transmitters.

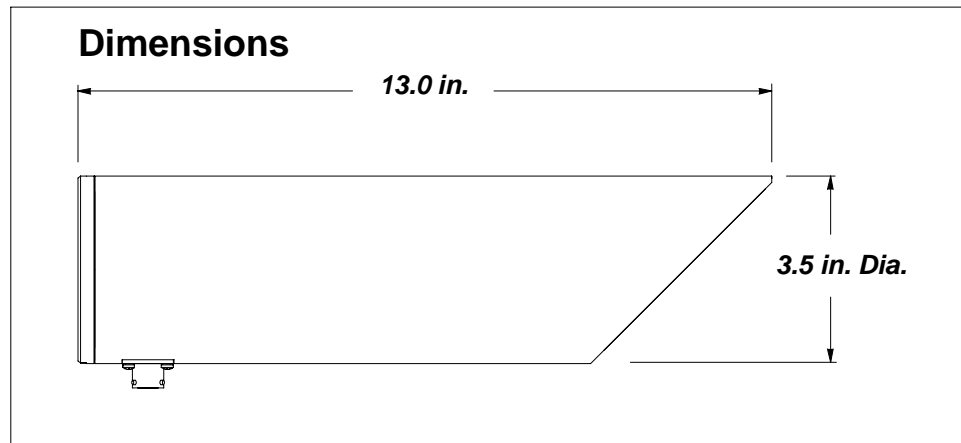

Figure 2.1

2.7 MOUNTING

Refer to Fig 1.2 which shows the effect of different mounting heights on coverage. An alignment telescope (AO55) is available to aid installation.

The telescope is an extremely sensitive long range detector. For this reason, mounting must be on a very stable structure. The very long, narrow detection field and high sensitivity of the telescope makes it susceptible to false alarms from motion if not mounted securely.

2.8 MOUNTING AND ACCESSORIES

The telescopes are easily mounted on any stable vertical pole or other solid structure. For stable mounting and easy aiming the following accessories can be supplied:

Double Mounting Bracket No. AO54M1

The part clamping the telescope is fixed to a platform with a nut for adjustment of the elevation. The other part is fixed to the pole with 360° rotation capability for aiming the telescope to any desired direction. Suitable for pole diameters of 1.5 to 3.0 inches.

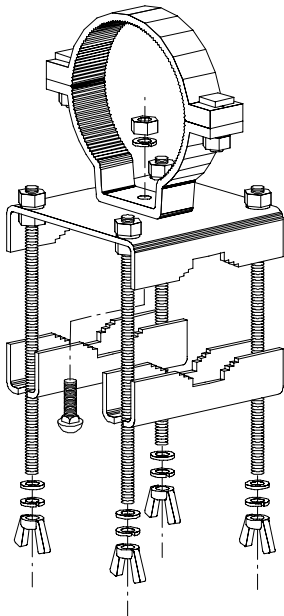

Mounting Bracket No. AO56M1

This is only the part actually clamping the telescope (mounting ring and base connection of AO54M1). Suitable for other ways of mounting (e.g. walls or tripods).

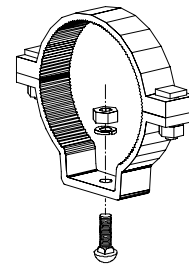

Telescopic Sight No. AO55

The telescopic sight can be placed on top of the telescope as an alignment aid and removed afterwards. A recticle indicates the center of the field of view.

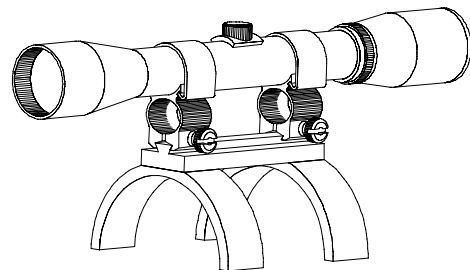

2.9 OPERATION

Mounting

First aim the telescope at the desired direction and fix it firmly as previously described.

Electrical Connections

Connect electronics to the telescope's connector, observing proper connections listed in section 2.4.

Power-Up

When the power is applied to the telescope, there is a period of approximately 2 to 5 minutes during which the internal circuitry stabilizes. During this period, the telescope sensitivity may vary slightly as the internal temperature stabilizes. Allow 5 minutes for complete stabilization.

Nuisance Alarms

When the telescope registers what seems to be false alarms overnight, it is sometimes difficult to identify the source of the problem. Often it is small animal activity which may be confined to only one section of a perimeter. Sometimes it is branches or other vegetation being moved by the wind into the telescope's field of view. A good approach is to "blind" the telescope with an opaque bag - testing that it is indeed rendered insensitive to motion. Then if the unit alarms in the trouble period, the source may be the power supplied to the telescope (an unlikely problem if other telescopes run from the same supply), a fault with the telescope itself or a fault with the associated electronics. If the telescope does not alarm through the trouble period when blinded, then the actual field of view should be verified by walk testing to insure that the telescope is not picking up distant vehicles or motion from an adjacent area. In addition, many telescope users have used the scope output to trigger a recording CCTV system with time/date stamp for alarm source verification. This approach is highly recommended.

2.10 ALIGNMENT

To align the telescope for small installations, walk testing is recommended. This is the best way to make final adjustments to the detection area.

For large installations, it is recommended to use the optional alignment telescope (AO55) for initial aligning with final placement optimized by walk testing.

2.11 WALK TESTING

Final aiming is done by walking across the field of view and observing the point where an alarm is triggered.

2.12 WALK TESTING HORIZONTAL FIELD-OF-VIEW

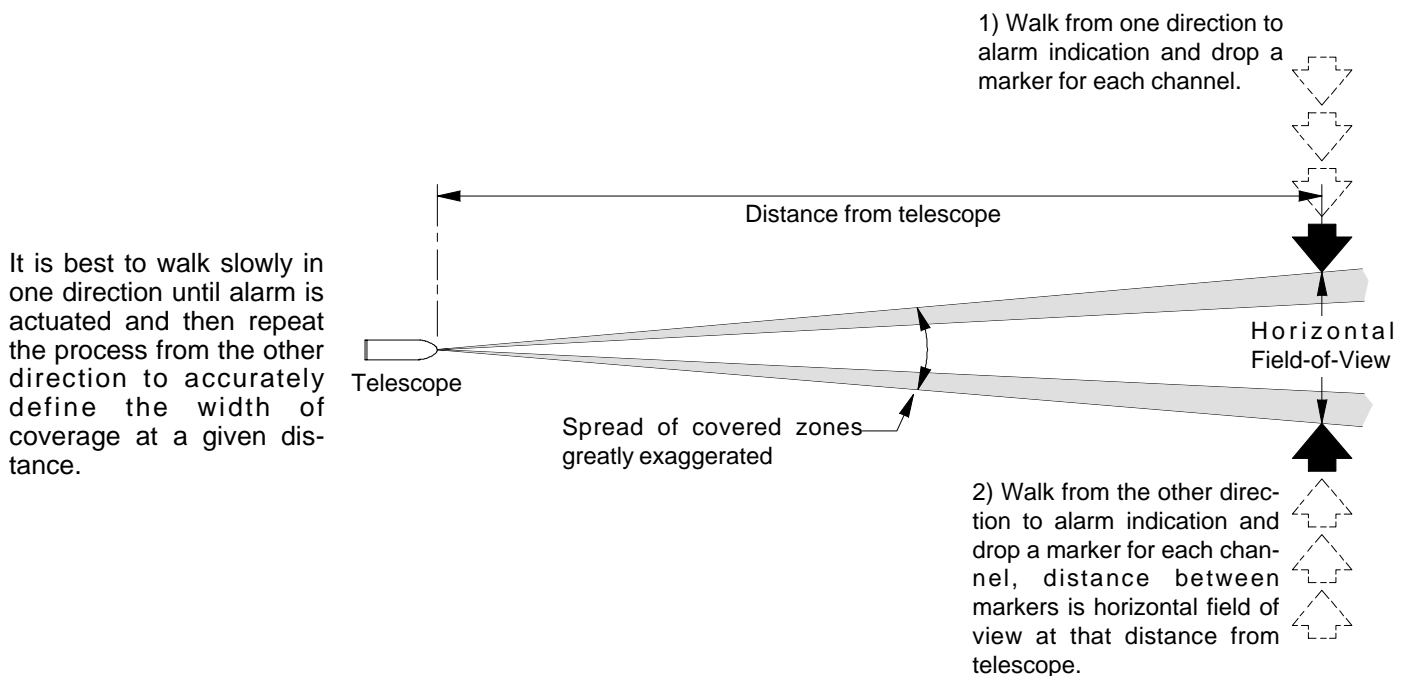

2.13 MAINTENANCE

Servicing

The telescopes are sealed units. The only servicing required is to clean the front window every 90 days with a clean, soft cloth. This may need to be done more often in dusty environments. Cloth may be moistened with distilled water in severe conditions. Clean the window very gently, do not apply undue pressure as the window is fragile and may be damaged or broken. At the same time, the detection field should be walk tested to check its sensitivity. Should problems arise, please contact our Technical Support staff for advice.

DO NOT TOUCH THE WINDOW WITH BARE HANDS. SALTS AND ACIDS FROM THE HANDS MAY DAMAGE THE SURFACE OF THE WINDOW.

THE TELESCOPE CONTAINS NO USER SERVICEABLE PARTS AND IN THE EVENT OF FAILURE SHOULD BE RETURNED TO ELTEC INSTRUMENTS, INC. FOR REPAIR. THE TELESCOPE IS HERMETICALLY SEALED AND NITROGEN BACKFILLED. ANY DISASSEMBLY WILL COMPROMISE THE SEAL AND VOID THE WARRANTY.

2.14 MODEL 860M1 / 860M5 / 860M6 SPECIFICATIONS

Mechanical

Weight	2 lbs, 12 oz
Size	3.50" (8.89 cm) dia x 12.93" (32.84 cm) long
Enclosure	Painted PVC, hermetically sealed
Color	O.D. Green (other colors available as special order)

Optical

Nominal Range	500 ft (152 m) with appropriate customer-supplied electronics
Spectral Response	8 to 14 microns, double filtered
Detectors	Two channel Lithium Tantalate Pyroelectric

Electrical

Supply Voltage	3 to 15 VDC
Supply Current	25µA max
Output	Analog

Environmental

Operating Temperature Range	-40° to +70°C
Storage Temperature Range	-40° to +70°C
Atmospheric Pressure	1 atmosphere (15 PSI) positive or negative (vacuum)
Sealing	Watertight hermetic seal

Note: Housing is hermetically sealed and nitrogen backfilled to prevent condensation of moisture on the optics at low temperature. Any disassembly of this unit will break the seal and void the warranty.

2.15 ACCESSORIES

AO54M1	=	Double Mounting Bracket
AO55	=	Removable Telescopic Sight
AO56M1	=	Single Mounting Bracket (Split Ring)

Notes:

NOTICE: The information provided herein is believed to be reliable. However, ELTEC Instruments, Inc. assumes no responsibility for inaccuracies or omissions. Due to industry components being incorporated into ELTEC's devices and ELTEC continually striving for product improvement, specifications may change without notice.



ELTEC Instruments, Inc. P.O. Box 9610 Daytona Beach, Florida 32120-9610 U.S.A.
Tel (USA and Canada): (800) 874-7780 Tel (Outside USA): (386) 252-0411 Fax: (386) 258-3791
Web: www.eltecinstruments.com E-Mail: Sales@eltecinstruments.com

©ELTEC INSTRUMENTS, INC. 07/2009 Printed in U.S.A. Form DS860M1-5-6 (E-07/2009)

International Visibility Scale				
Points	Qualitative Visibility	Range of Visibility	Transmissivity per Kilometer	Atmospheric Conditions
0	Very Poor	0 - 50 m	$< 10^{-6}$	Very dense fog
1		50 - 200 m	$10^{-4} - 10^{-6}$	Dense fog; very heavy snow
2		200 - 500 m	$10^{-3} - 10^{-4}$	Moderate fog; heavy snow
3	Poor	500 - 1,000 m	$10^{-2} - 10^{-3}$	Light fog; moderate snow; thick haze
4		1 - 2 km	0.02 - 0.15	Moderate snow; very heavy rain; moderate haze
5	Intermediate	2 - 4 km	0.15 - 0.4	Light snow; heavy rain; thin haze
6		4 - 10 km	0.4 - 0.7	Moderate rain; very light snow; thin haze
7	Good	10 - 20 km	0.7 - 0.8	Light rain; no precipitation
8	Very Good	20 - 50 km	0.8 - 0.9	No precipitation
9	Exceptional	> 50 km	0.9 - 1.0	Perfectly pure air

Notes: 1. The transmittance refers to $\lambda = 0.61 \mu$. 2. The values for 0 - 3 points are rough estimates due to meager experimental data.
(Bramson: Infrared Radiation, Plenum Press, N.Y., 1968)

TABLE 1



ELTEC Instruments, Inc. P.O. Box 9610 Daytona Beach, Florida 32120-9610 U.S.A.
 Tel (USA & Canada): (800) 874-7780 Tel (Outside USA): (386) 252-0411 Fax (386) 258-3791
 Web: www.eltecinstruments.com E-Mail: Sales@eltecinstruments.com